

ACCUTEX TECHNOLOGIES CO., LTD.

NO.20,Jingke Rd, Nantun District, Taichung City 40852,Taiwan.
+886-4-2359-9688
+886-4-2359-7266
www.accutex.com.tw
sales@accutex.com.tw
info@accutex.com.tw
service@accutex.com.tw



GA Series

Wire Cut EDM

The Best Solution of CNC Wire EDM Technology



Environmental Requirements

Power Source	AC220V / AC380±5% :3 Phase 50/60Hz±1Hz
Temperature	20±1°C or 25±1°C ; less than 75%RH
Environment	<ol style="list-style-type: none"> 1.The machine should not be placed near punching machine,drilling machine or any interfering sources. 2.The machine should not be placed near heat treatment or electroplate systems. 3.The machine be placed in an airtight room to keep dust out. 4.Before machine positioning, pay attention to machine movement during operation and the space needed for maintenance. 5.Solid foundation of horizontal error should be less than 20µm.
Earth construction	Earth resistance below 10Ω: separate the earth terminal with other machines.
Pneumatic pressure	6 kg/cm ² (Applicable for machine with AWT system)

*All the specifications are subject to change without prior notice.

High-Rigidity Structure

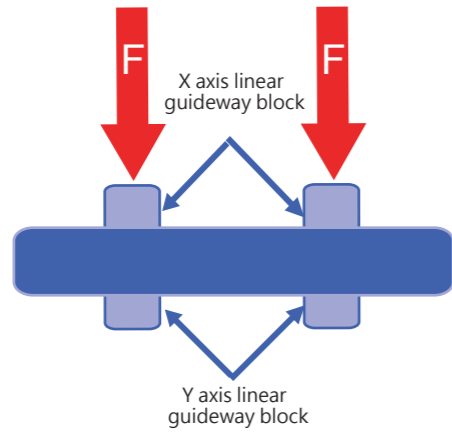
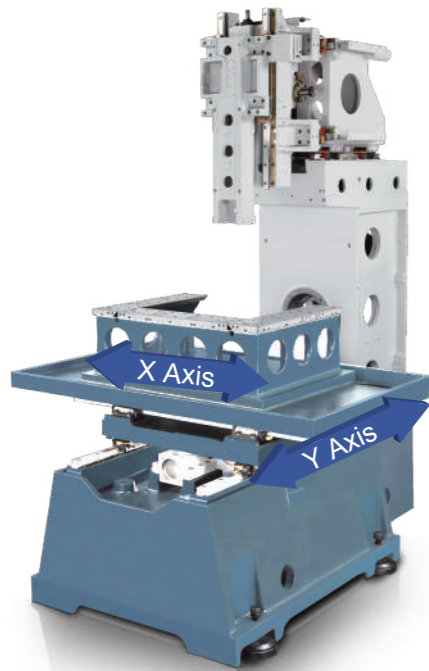

GA series has "Direct Force" design on the concept of X/Y axes linear guideway blocks keep staying in straight line. Working table is supported by casting bases. GA series is suitable for the precision mold cutting within small / medium stroke.

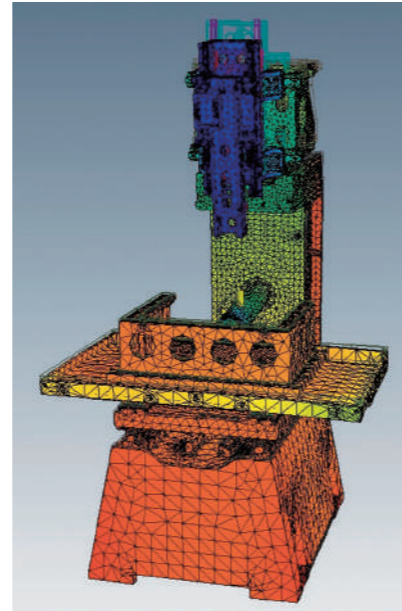

Machine structure was designed via Finite Element Analysis (FEA) with high rigidity.

Windows CE Controller



AccuteX controller is 100% self-developed by core-technologies of R&D team. We can provide the best support in any modifications. AccuteX controller is based on Windows CE system. It features "Precise Motion Control" with rapid servo response. Also, Windows CE system is virus free environment to assure system stability.

Auto Wire Threading (*Optional)



- >"AC servo tension wheel", tension control during cutting, featuring reverse tension while wire breaks.
- >"Wire End Needle-Shaping", while the wire is cut off by electricity, the reverse tension and annealing heat treatment are applied to strengthening the wire at the same time.
- >"Waste Wire Auto Removing Device" by air blow system to remove waste wire to the collection cabinet, quick and easily.



Industry 4.0- Intelligent Manufacturing Integration System

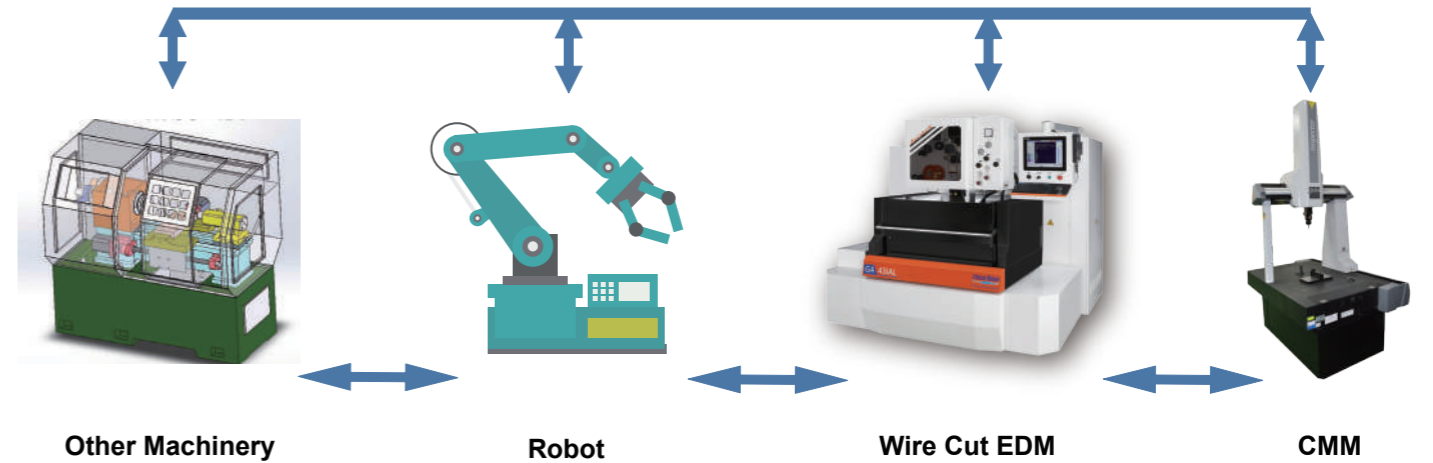

AccuteX machine is capable with industry 4.0 who has M2M (machine to machine) protocol to collaborate with Robots and other machines. Flexible Real-time production can be made by Intelligent Manufacturing Integration System to meet full-automation demand.

Linear Motor

New generation shaft-type linear motor is self-developed by AccuteX. It features with closed loop control by 0.2μm resolution linear scale and backlash free to keep accuracy. Rapid servo response can improve cutting efficiency up to 10%. AccuteX linear motor has excellent lower power consumption to keep constant working temperature.

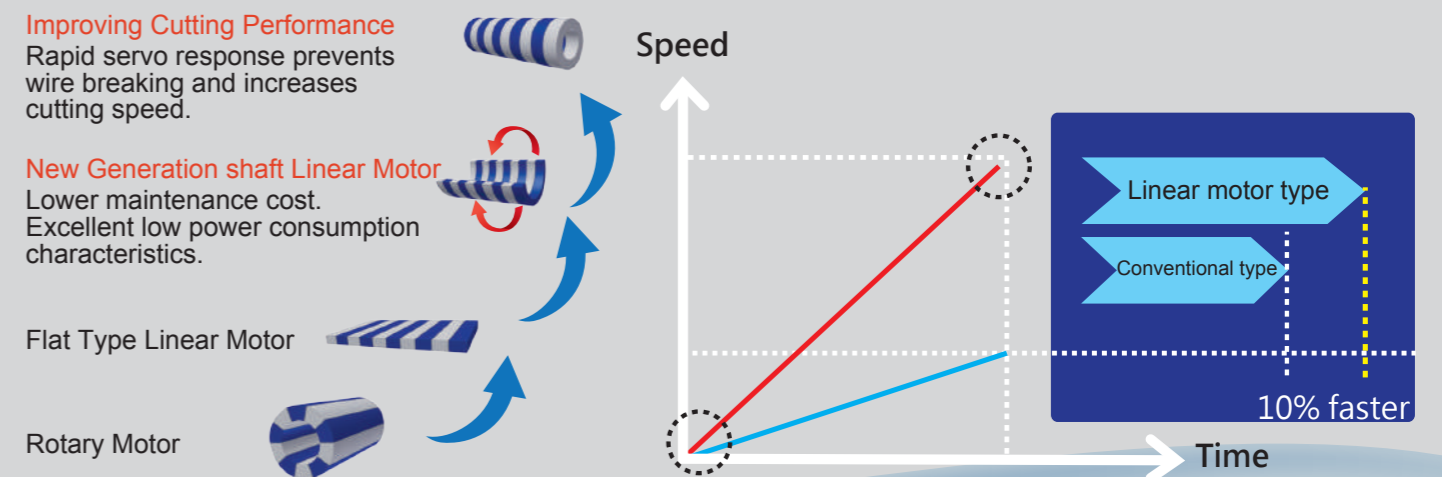

Ultra Resolution Signal Processor

Linear scale interpolation board with ultra resolution to achieve smoother velocity and stabilize position control. Standard resolution is 0.2 μ m.

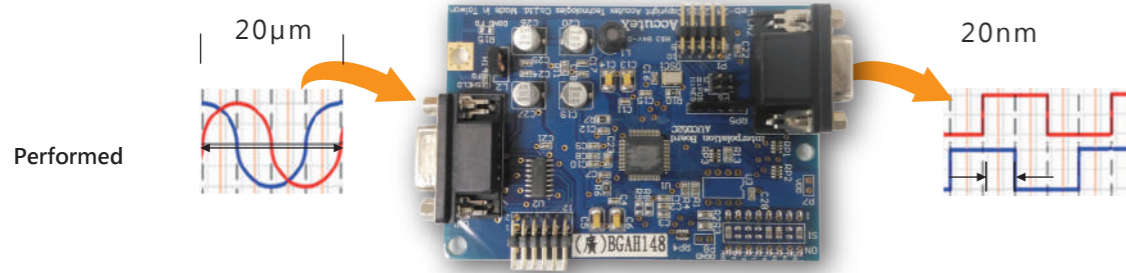

Standard scale can narrow down to 20nm.

Cutting Efficiency Comparison

AccuteX has simplified the generator and electric circuits to eliminate unnecessary power loss and improve the cutting efficiency. Speed comparison table with other brands in different thickness of workpieces.

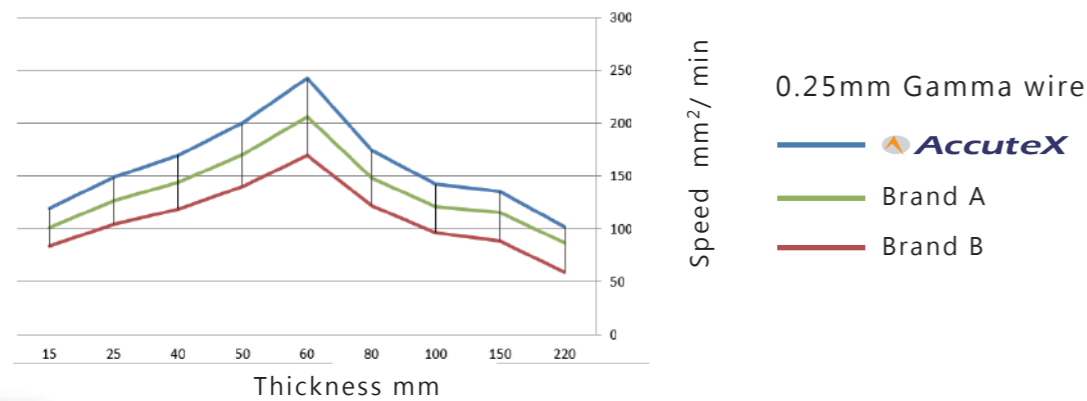

Corner Control Function

According to different wire diameters, corner angles, arc radius and thicknesses, AccuteX controller optimizes parameters for the best cutting efficiency with high accuracy. Especially on the small path and continuous corners, machines can meet the corner accuracy demand.

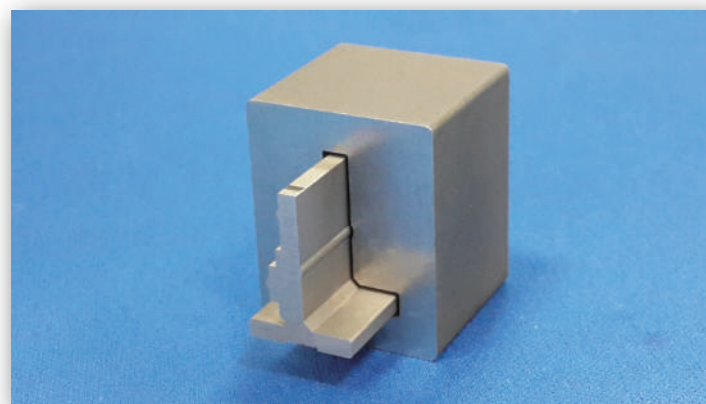

The complex stamping mold has fine 3 μ m tolerance with average 1mm height of cutting edge.

Item	Note
Material	SKD11
Thickness	Punch 30mm / Die 16mm
Wire	0.25mm
Cut	3

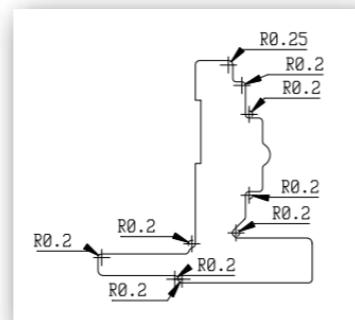

Rotary Table Package (*Optional)

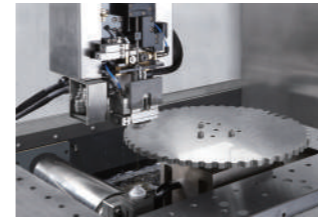

Vertical mode



Horizontal mode

Accutex Rotary Table Package is leading ahead of other WEDM manufacturers by years in R&D which can be applied to submerged operation.

The Built-in Type Motorized Spindle features ultra-high resolution 720,000 pulses each revolution, free of backlash problems.

Probing Measuring System (*Optional)

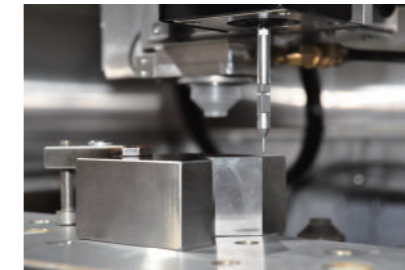

"Probing Measuring System" detects feature of Non-Leveling workpiece. It compensates error by integrated 3rd party CAD/CAM software and improve workpiece accuracy. It's available for mass-production with automation application.

New Lead-In / Lead-Out Control

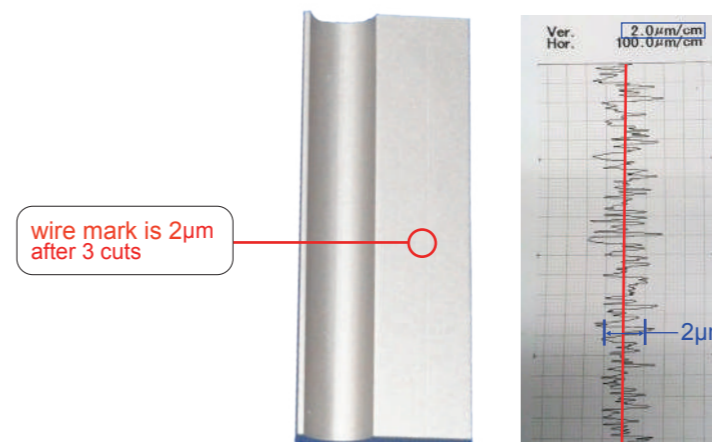

New generation of Lead-In / Lead-Out function is available for Tungsten Carbide. The wire mark is 2 μ m after 3 cuts by 40mm thickness which improving mold quality and saving second time polishing hours.

Cutting Samples

Continuous Corner

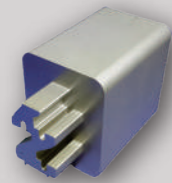

- Keeping equal tolerance 3μm in continuous corner.
- Continuous radius is 0.18mm Short path is 0.207mm.

Material	SKD11
Thickness	Punch 50mm Die 30mm
Wire size	0.25mm
Passes	3

Stamping Mold

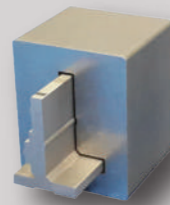

- Continuous corner.
- The mold has fine 3μm tolerance with average 1mm height of cutting edge.

Material	SKD11
Thickness	Punch 30mm Die 16mm
Wire size	0.25mm
Passes	3

High Slenderness Ratio & Complex Profile Assembly Parts

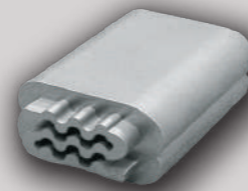

- Stamping mold application.
- Maximum tolerance is less than 5μm/80mm.

Material	SKD11
Thickness	80mm
Wire size	0.2mm
Passes	3

Machine Specifications

	GA-43	GA-53
Max. Workpiece Size L x W x H (mm)	880 x 630 x 215	880 x 630 x 215
Max. Workpiece Weight (kg)	400	500
X/Y Stroke(mm)	400 x 300	500x300
U/V Stroke (mm)	60	60
Z Stroke(mm)	220	220
Max. Cutting Taper (mm)	±15° / H80mm	±15° / H80mm
Max. wire Spool Weight (kg)	10	10
Footprint (mm)W x D x H	2209x2402x1994	2209x2402x1994
Water System Capacity (L)	645	645
Machine Weight (kg)	2800	3000

(*) "A" stands for AWT optional function. (*) "L" stands for linear motor optional function.

Controller Functions

Backlash compensation	Pitch compensation	Program management	Program edit
Anti- Collision	Cutting path display	Linear/Circular interpolation	Auto corner
N code jump	Sub program	Multi-blocks skip	Corner control function
MDI function	Taper cutting	Different shape interpolation	Optional stop
Single block	Mirror	Rotation	Axis exchange
Short back	Constant / Servo feed	2 nd Soft limit	Parallel compensation
Auto position (edge, center)	Dry run	Block stop	Reference point setting
Reference point return	Start point return Retrace to start point	Auto power recovery	Diagnosis
Cutting log	Maintenance memo	Lead-In / Lead-Out Control	

Standard Accessories

- SD Master
- Manual Sliding door
- Upper / Lower Flushing Nozzle
- Diamond Guide
- Conductor Plate
- Brass Wire
- Ion Exchange Resin
- Ion Resin Tank
- Paper Filter
- Waste Wire Bin
- Vertical Alignment Jig
- Diamond Guide Remove Jig
- Tools and Clampers
- Tool Box

Tall Assembly Parts

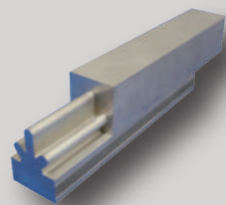

- Maximum profile tolerance is 5μm/100mm. The straightness from top to bottom is 2μm/100mm.

Material	SKD11
Thickness	100mm
Wire size	0.25mm
Passes	3

Lead-In / Lead-Out



- 2μm wire mark on thickness 40mm tungsten carbide after 3 cuts.
- Only turn on the function without any cutting path modifications.

Material	Tungsten Carbide
Thickness	40mm
Wire size	0.25mm
Passes	3

Angle Lifter



- Best tolerance in taper assembly parts.

Material	SKD11
Thickness	30mm
Wire size	0.2mm
Fine Finish	Ra<0.5μm
Passes	3

Controller Specifications

Controller System	Windows CE
Control Device	64-bit Industrial PC
Memory Device	≥1GB CF Card
Screen Display Device	15" Color TFT Screen
Data Input	Keyboard, Mouse Pointer, RS-232, USB, Ethernet, FTP
No. of Control Axes	5 Axes/ 6 Axes(Option on W Axis)
Simultaneous Axes	4 Axes/ 5 Axes(Option on W Axis)
Min. Command Unit	0.0001mm
Max. Command Range	±9999.9999mm
Command Type	mm/inch
Cutting data Memory	99999 Sets
Ignition Power Supply	32 Steps · 53V~138V
On time	24 Steps
Off time	43 Steps
Discharge Mode	Rough Cut / Skim Cut

Optional Accessories

- Transformer
- Auto Voltage Stabilizer
- Water Chiller
- PCD / Graphite Power Module
- S Power Module
- Rotary Table Package (W axis)
- XY Axes Liner Motor
- 0.2μm Resolution Linear Scale
- Auto Wire Threading (AWT)
- High Pressure Water Jet Threading
- 45Kg Wire Jumbo Feeder
- Remote Master
- GSM Messenger
- Anti-Collision on Z-Axis
- Industry 4.0 Intelligent Manufacturing Integration System
- Safety Door Interlock
- Machine Status Indicator
- Touch Screen

PCD Application

(Optional PCD Graphite power)

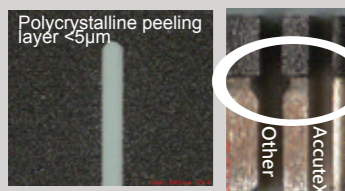

- Polycrystalline peeling layer is <5μm by optional PCD power with less grinding hours.
- Clear fit between PCD and carbide connection.

Material	PCD
Thickness	1mm
Wire size	0.2mm
Passes	1

Helical Gear Cutting

(Rotary Table Optional)



- Vertical type for rotary table application
- Gear diameter is 380mm

Material	Steel
Thickness	25mm
Wire size	0.25mm
Passes	2

HD Gear



- Precision transmission part.
- Lead-in/Lead-out wire mark is <2μm. The profile deviation of each gear is <5μm.

Material	SKD11
Thickness	10mm
Wire size	0.15mm
Passes	4